

Data Sheet



Article number: 021500700114

Description: Sealing Clamp S 114 W5

Measures

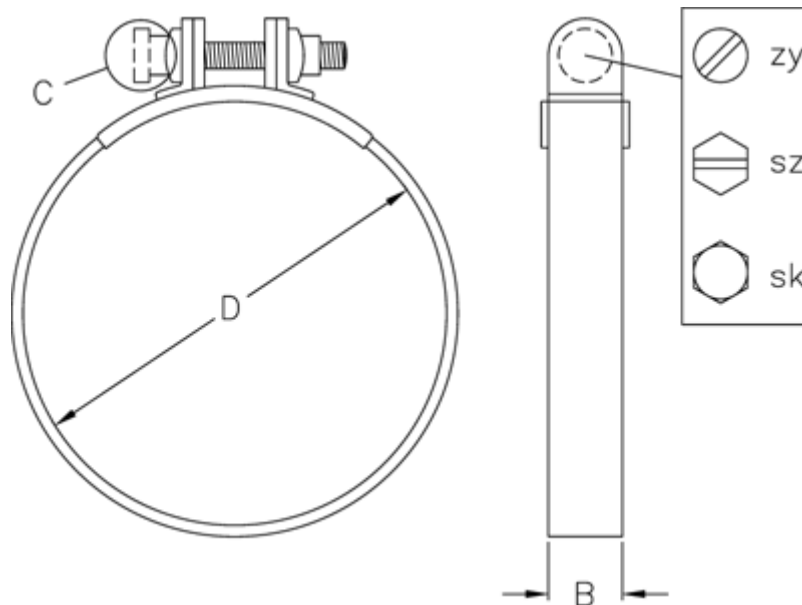

C (screw type)	= SZ
Diameter D	= 114
Width B	= 20